

TECHNICAL DATA FOR REFERENCE ONLY!!

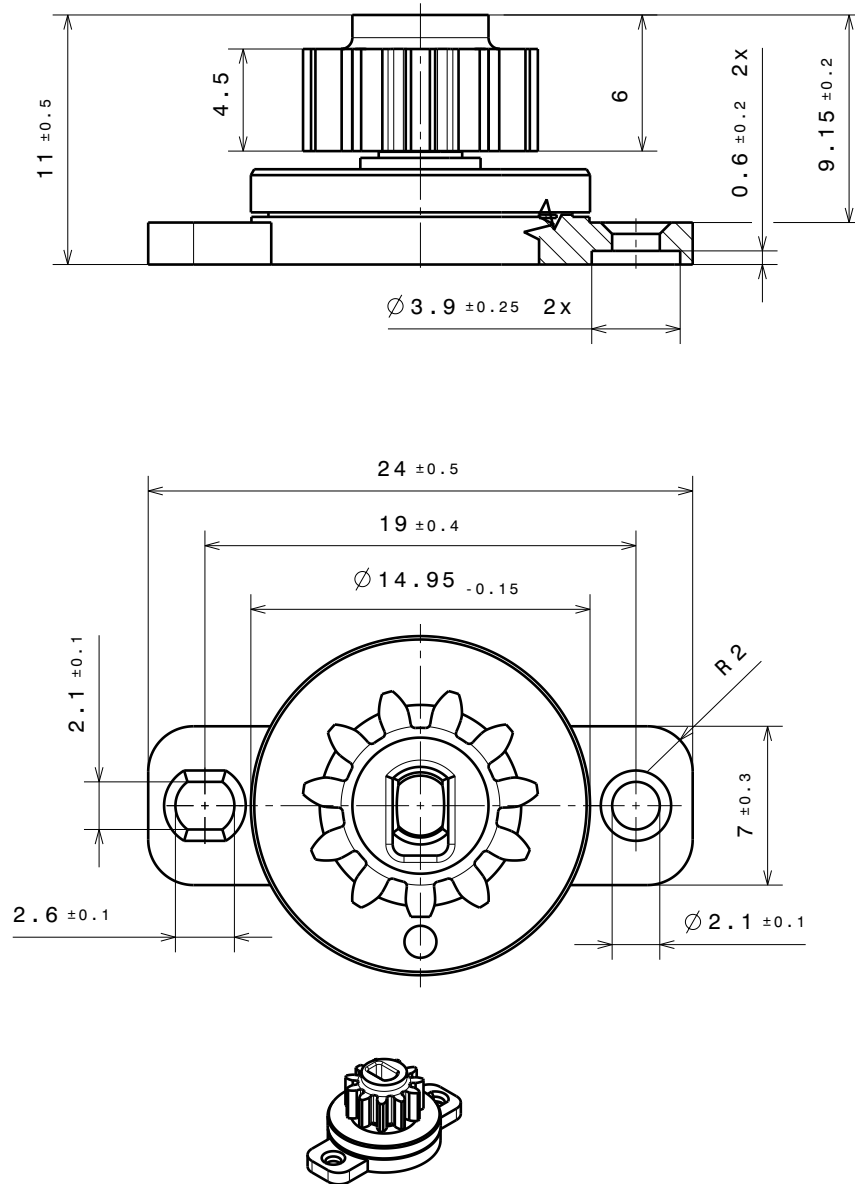

Torque at RT and 20 rpm.	Torque ID
2.50 ± 0.45 Ncm	I
2.20 ± 0.40 Ncm	M
1.50 ± 0.30 Ncm	F
1.10 ± 0.25 Ncm	L
0.95 ± 0.20 Ncm	Z
0.70 ± 0.17 Ncm	D
0.55 ± 0.15 Ncm	E
0.45 ± 0.15 Ncm	S
0.25 ± 0.10 Ncm	Y
0.15 ± 0.08 Ncm	H

GEAR SPECIFICATION	
tooth engagement	20°
module	0.8
number of teeth	11

G SMALL STANDARD DAMPER

30300

11 Tooth Gear
PART NO. 30300-9-00-X3X